

# 36" Standard Line Clamp

## Product Information



### Features:

- Designed for use on 36" pipe
- Cam style (aka hand lever or toggle) clamps are quick and efficient pipe clamps
- Hydraulic style clamps use a hydraulic mechanism to secure the clamp to the pipe joint
- Standard line clamps are a cost effective alternative to the Classic Ratchet Line clamps
- Clamp will align up to schedule 80 pipe
- Ring spacing enables easy access to pipe joint
- Available **No Tack Pads** are arched away from the pipe, enabling better access to the weld joint and increasing weld efficiency
- Available **Stainless Steel Pads** for welding on stainless steel or specialty pipe
- Clamp inside diameter is sized 1/8" larger than nominal pipe diameter
- Note: hydraulic jack should only be operated while in the vertical position

**Before use, read the WARNING below**

PRODUCT DETAILS		
Clamp Type:	CAM/TOGGLE	HYDRAULIC
Part #:	KCS-36-C	KCS-36-H
Weight:	162 lbs (73kg)	195 lbs (88 kg)
Clamp Material:	Carbon Steel	Carbon Steel
Hydraulic Jack Rating:	N/A	24,000lb (12T)
No-Tack Pads Option Part #:	KCS-36-C-NT	KCS-36-H-NT
Stainless Pads Option Part #:	KCS-36-C-SS	KCS-36-H-SS

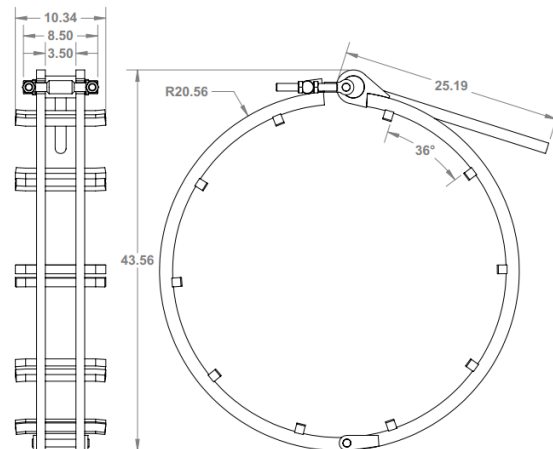
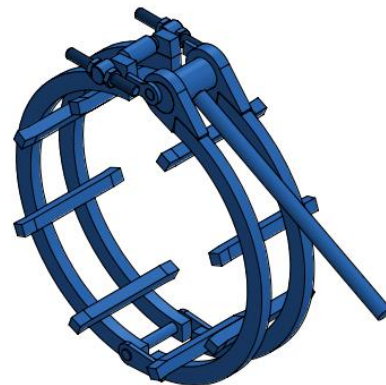

No-Tack Pad Example



Stainless Steel Pad Example

**WARNING!** 1. Do not use the alignment clamp as a lifting device. 2. K.C. alignment clamps are not to be used as a load bearing device. 3. A lift mechanism should not be attached to the clamp to lift the pipe. 4. Wedges should not be driven under the frame of the clamp in an attempt to reform the pipe as it may damage the clamp and void the warranty. 5. The clamp is not designed for the alignment of the tees, elbows, valves and other fittings. 6. The clamp should not be used with any type of device that is used to preheat the pipe prior to welding as this may result in failure of the clamp. 7. Do not use a mechanical advantage (such as a cheater bar) on the end of the cam or hydraulic jack handle.